

PLA10AS7720R7D2B

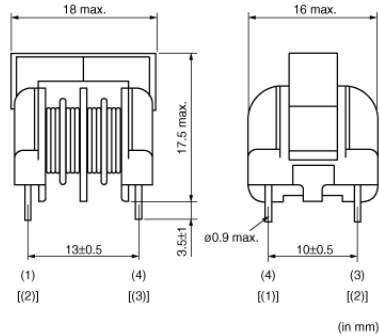

Appearance & Shape



Packaging Information

Packaging	Specifications	Minimum Order Quantity
-	Box	1260

Attention

- 1.This datasheet is downloaded from the website of Murata Manufacturing Co., Ltd. Therefore, it's specifications are subject to change or our products in it may be discontinued without advance notice. Please check with our sales representatives or product engineers before ordering.
- 2.This datasheet has only typical specifications because there is no space for detailed specifications.
Therefore, please review our product specifications or consult the approval sheet for product specifications before ordering.

PLA10AS7720R7D2B



Specifications

Common Mode Inductance(min.)	7.7mH
DC Resistance(max.)	0.95Ω
Rated Current	0.7A
Length	18mm max.
Width	16mm max.
Thickness	17.5mm max.
Operating Temperature Range	-25°C to 60°C
Winding Temperature Rise(at Rated Current)(max.)	60°C
Rated Voltage	250Vac
Insulation Resistance(min.)	100MΩ
Withstanding Voltage	2000V(AC)(1minute) or 2400V(AC)(1second)
Mass(typ.)	7.2g
Winding Mode	Sectional Winding

Attention

- 1.This datasheet is downloaded from the website of Murata Manufacturing Co., Ltd. Therefore, it's specifications are subject to change or our products in it may be discontinued without advance notice. Please check with our sales representatives or product engineers before ordering.
- 2.This datasheet has only typical specifications because there is no space for detailed specifications. Therefore, please review our product specifications or consult the approval sheet for product specifications before ordering.

PLA10AS7720R7D2B

Product Data

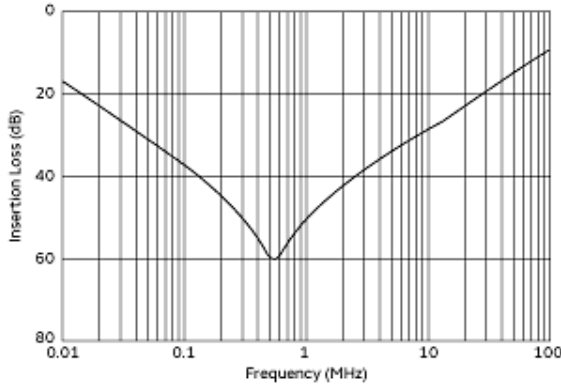

Insertion Loss Characteristics

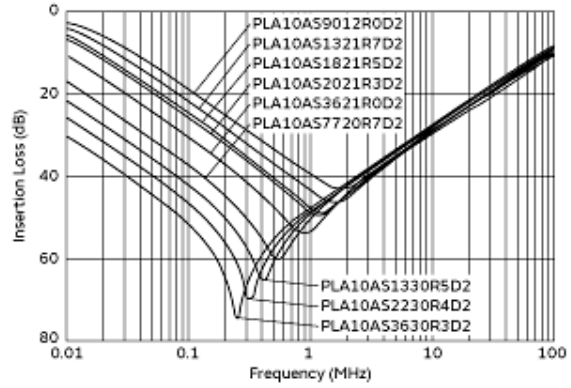

Insertion Loss Characteristics (Main)



Equivalent Circuit

Attention

1.This datasheet is downloaded from the website of Murata Manufacturing Co., Ltd. Therefore, it's specifications are subject to change or our products in it may be discontinued without advance notice. Please check with our sales representatives or product engineers before ordering.
2.This datasheet has only typical specifications because there is no space for detailed specifications.
Therefore, please review our product specifications or consult the approval sheet for product specifications before ordering.