

# Multiband Chip Antenna

**ACAJ-109-T**

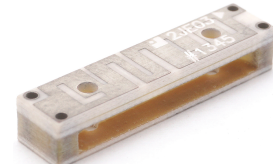

RoHS / RoHS II Compliant



24.0 x 5.5 x 4.4 mm

Moisture Sensitivity Level (MSL) – MSL = 1

## FEATURES:

- Passive Penta-Band antenna (824MHz ~ 2170MHz)
- Covering GSM850, GSM900, DCS, PCS, & UMTS
- SMA mount, Reflowable to 260 degrees C max.
- Dimensions (24.0mm x 5.5mm x 4.4mm)
- Peak Gain variable across bands from 1.3 ~ 6.4dBi
- VSWR 3.0:1 Max (measured on matched EV board)
- Impedance 50 Ohms
- Linear Polarization / Omni-directional azimuth pattern
- RoHS/RoHS II compliant

## APPLICATIONS:

- GSM850/900MHz
- DCS
- PCS
- UMTS
- Embedded applications

## STANDARD SPECIFICATIONS

### Description

The ACAJ-109-T product is a multi-band antenna that can be tuned to different bands by modifying its matching circuit. The antenna is constructed from a dielectric ceramic material with Ag patterns to form the antenna performance.

### Electrical Characteristics for GSM850

ITEM		SPECIFICATION			
Frequency Range		824 ~ 894MHz			
VSWR		3.5: 1 Max			
Polarization		Linear			
Azimuth Beam Pattern		Omni-directional			
Impedance		50Ω			
Operating Temperature		-35°C to + 85°C			
Frequency [MHz]		824	849	869	894
Gain [dBi]	Peak	-0.3	-0.2	0.4	1.3
	Average	-3.7	-3.6	-3.3	-2.5
Efficiency [%]		42.4	43.8	47.1	56.1

### Electrical Characteristics for GSM900

ITEM		SPECIFICATION			
Frequency Range		880 ~ 960MHz			
VSWR		3.5: 1 Max			
Polarization		Linear			
Azimuth Beam Pattern		Omni-directional			
Impedance		50Ω			
Operating Temperature		-35°C to + 85°C			
Frequency [MHz]		880	915	925	960
Gain [dBi]	Peak	1.5	2.2	2.4	1.8
	Average	-2.4	-1.9	-1.8	-2.3
Efficiency [%]		57.3	64.6	65.8	58.2

# Multiband Chip Antenna

ACAJ-109-T

 RoHS / RoHS II Compliant 

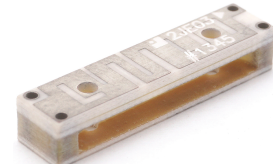

24.0 x 5.5 x 4.4 mm

## STANDARD SPECIFICATIONS

### Electrical Characteristics for DCS1800

ITEM		SPECIFICATION			
Frequency Range		1710 ~ 1880MHz			
VSWR		3.0 : 1 Max			
Polarization		Linear			
Azimuth Beam Pattern		Omni-directional			
Impedance		50Ω			
Operating Temperature		-35°C to + 85°C			
Frequency [MHz]		1710	1785	1805	1880
Gain [dBi]	Peak	6.4	5.8	6.1	5.4
	Average	-0.4	-0.9	-0.6	-1.1
Efficiency [%]		90.9	80.7	86.2	76.8

### Electrical Characteristics for PCS1900

ITEM		SPECIFICATION			
Frequency Range		1850 ~ 1990MHz			
VSWR		3.0 : 1 Max			
Polarization		Linear			
Azimuth Beam Pattern		Omni-directional			
Impedance		50Ω			
Operating Temperature		-35°C to + 85°C			
Frequency [MHz]		1850	1910	1930	1990
Gain [dBi]	Peak	5.6	5.9	5.8	5.5
	Average	-0.8	-0.5	-0.5	-0.6
Efficiency [%]		84.0	89.8	88.6	86.7

### Electrical Characteristics for UMTS2100

ITEM		SPECIFICATION			
Frequency Range		920~2170MHz			
VSWR		3.0 : 1 Max			
Polarization		Linear			
Azimuth Beam Pattern		Omni-directional			
Impedance		50Ω			
Operating Temperature		-35°C to + 85°C			
Frequency [MHz]		1920	1980	2110	2170
Gain [dBi]	Peak	4.8	4.5	4.6	4.5
	Average	-0.7	-0.9	-0.5	-0.2
Efficiency [%]		84.9	82.1	89.5	95.4

# Multiband Chip Antenna

**ACAJ-109-T**

**Pb** | RoHS / RoHS II Compliant | 

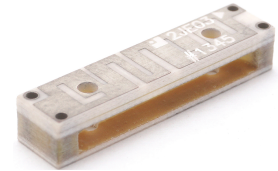

24.0 x 5.5 x 4.4 mm

## PART IDENTIFICATION:

ACAJ-109-

**Packaging**

Blank: Bulk

T: Tape and Reel

## S11 (VSWR)- Penta Band (GSM850&900, DCS, PCS, UMTS)

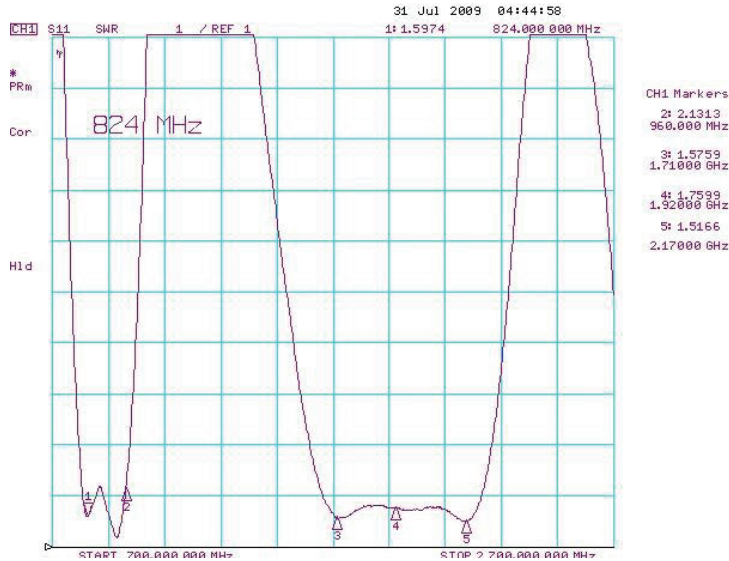

**VSWR on EV Board**

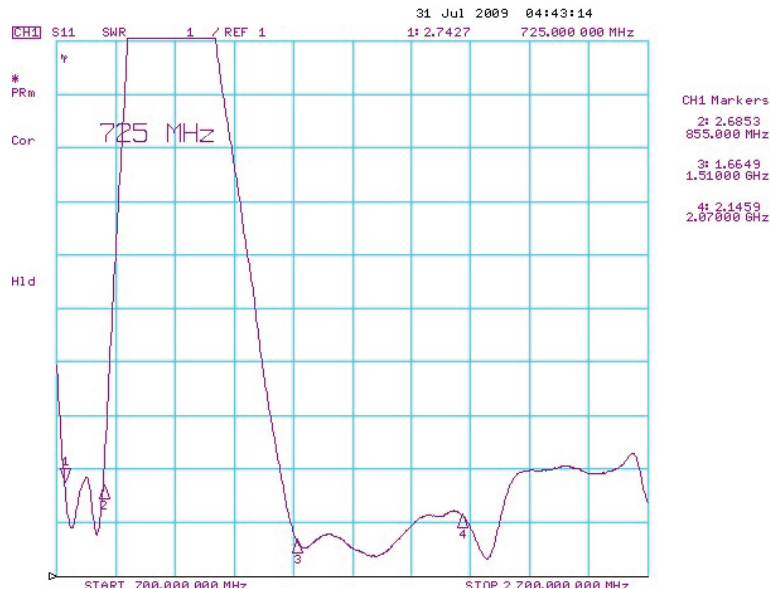

**VSWR @ Manual Jig**

# Multiband Chip Antenna

**ACAJ-109-T**

RoHS / RoHS II Compliant

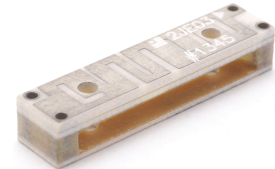

24.0 x 5.5 x 4.4 mm

## OUTLINE DIMENSION:

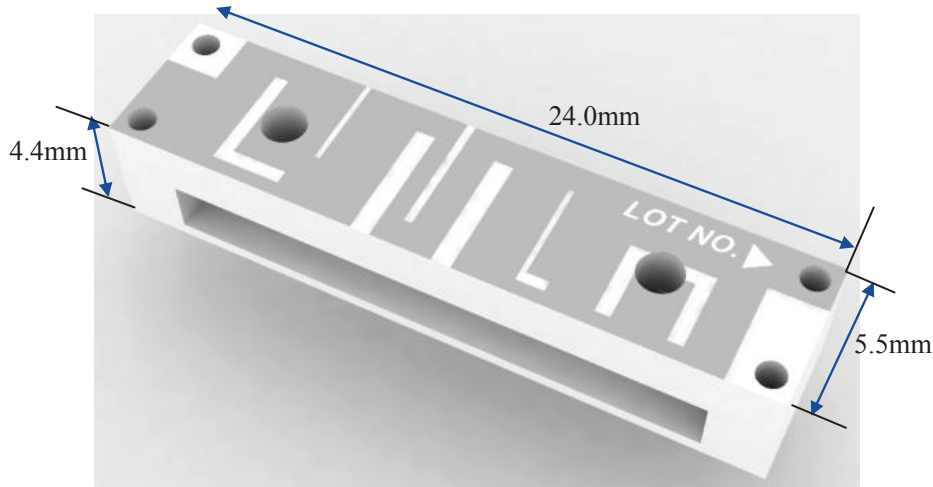

Tolerance:  $\pm 0.15$

## Recommended Land Pattern

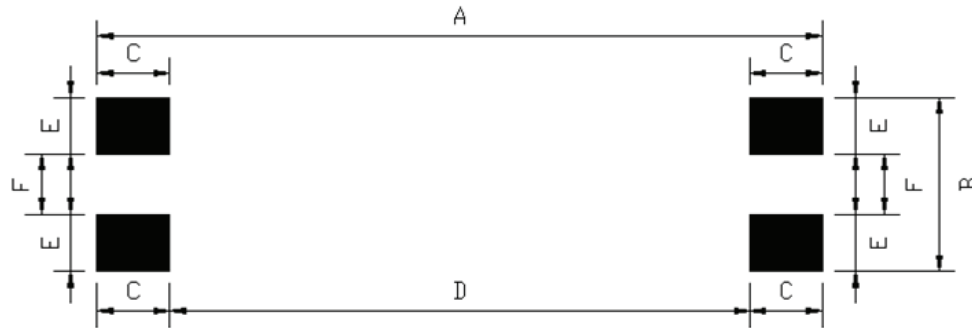

A	B	C	D	E	F
25.0	5.5	2.3	20.4	1.8	1.9

Unit: mm.1

## REFLOW PROFILE:

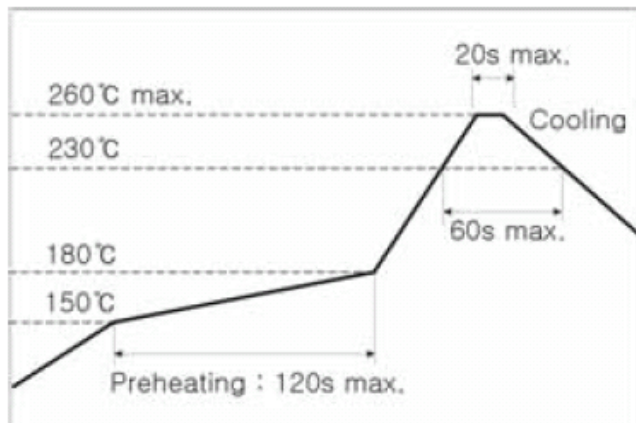

This product is designed for reflow soldering only. Do not use flow (wave) soldering. Use non-activated flux (Cl content 0.2% max.) Follow the recommended soldering conditions to avoid damage. Reflow-cycle is max. 3 times.

# Multiband Chip Antenna

ACAJ-109-T

RoHS / RoHS II Compliant

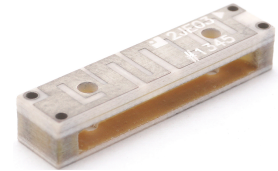

24.0 x 5.5 x 4.4 mm

## TAPE & REEL:

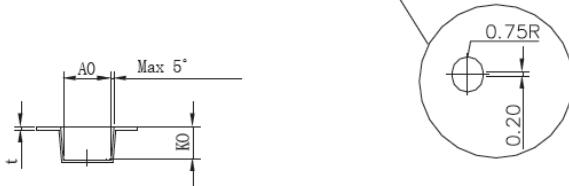
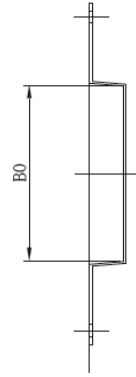
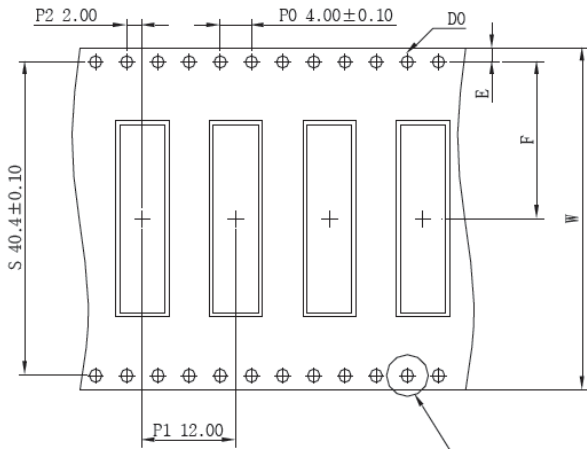

A0	5.80±0.20	E	1.75±0.10
B0	24.30±0.20	F	20.20± 0.20
K0	4.60±0.20	W	44.00±0.30
D0	1.55±0.05	t	0.40±0.05

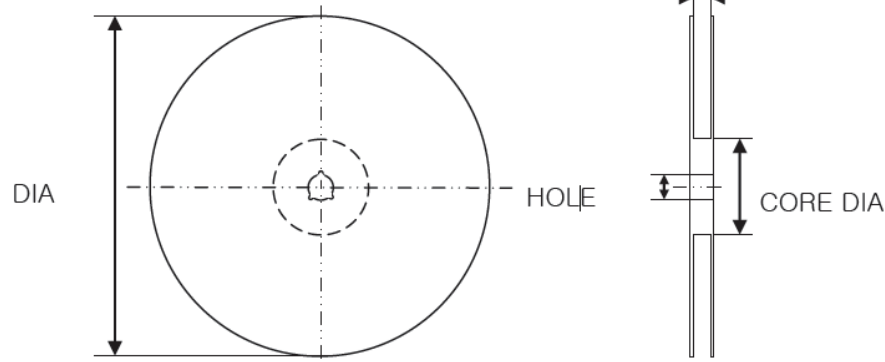

Item	Size (mm)
DIA	330.0 ± 2
WIDTH	45.5 ± 0.5
CORE DIA	100.0 ± 1
HOLE	13.0 ± 0.3

Package Quantity: 1000units/reel

**ATTENTION:** Abracon Corporation's products are COTS – Commercial-Off-The-Shelf products; suitable for Commercial, Industrial and, where designated, Automotive Applications. Abracon's products are not specifically designed for Military, Aviation, Aerospace, Life-dependant Medical applications or any application requiring high reliability where component failure could result in loss of life and/or property. For applications requiring high reliability and/or presenting an extreme operating environment, written consent and authorization from Abracon Corporation is required. Please contact Abracon Corporation for more information.

ABRACON IS  
ISO9001:2008  
CERTIFIED

**ABRACON**<sup>®</sup> LLC  
The Power of Linking Together

2 Faraday, Suite# B | Irvine | CA 92618 **Revised: 11.19.15**  
Ph. 949.546.8000 | Fax. 949.546.8001

Visit [www.abracon.com](http://www.abracon.com) for Terms and Conditions of Sale