

Honeywell

Honeywell Sensing and Productivity Solutions

AML36FBC4AC01

Artikelnummer: AML36FBC4AC01
 Tillverkare / Brand: Honeywell Sensing and Productivity Solutions
 Produktbeskrivning: SWITCH ROCKER DPST 15A 125V
[PDF](#) 1.AML36FBC4AC01.pdf
[PDF](#) 2.AML36FBC4AC01.pdf
[PDF](#) 3.AML36FBC4AC01.pdf
 Datablad:
 RoHS status: Blyfri / Överensstämmer med RoHS
 Skicka från: Hong Kong
 Leveransväg: DHL/Fedex/TNT/UPS/EMS

Productivity Solutions

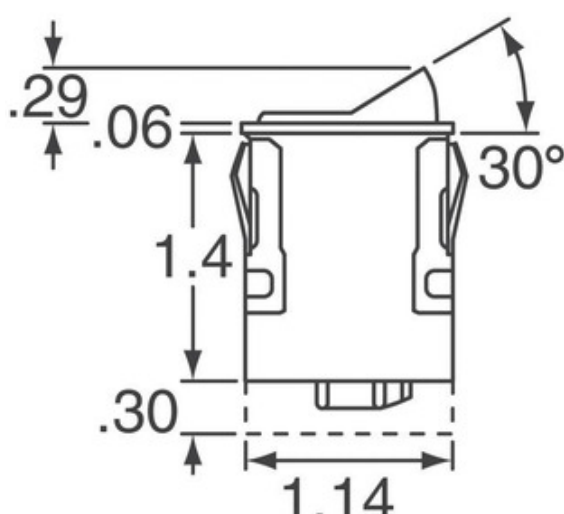

OFFERTFÖRFRÅGAN

Bilden kan vara representation. Se specifikationer för produktinformation.









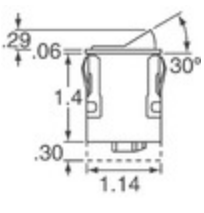
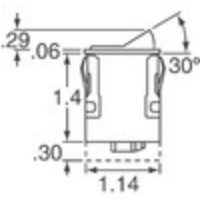

Specifikationer för AML36FBC4AC01

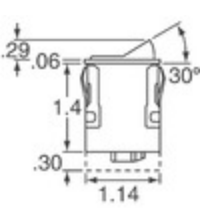
ARTIKELNUMMER	AML36FBC4AC01
TILLVERKARE	Honeywell Sensing and Productivity Solutions
BESKRIVNING	SWITCH ROCKER DPST 15A 125V
LEDNINGSFRI STATUS / ROHS-STATUS	Blyfri / Överensstämmer med RoHS
DATABLAD	PDF 1.AML36FBC4AC01.pdf PDF 2.AML36FBC4AC01.pdf PDF 3.AML36FBC4AC01.pdf
SPÄNNINGSVÄRDE - AC	125V
AVSLUTNINGSSLIT	Solder, Quick Connect - 0.187" (4.7mm)
BYT FUNKTION	On-Off
SERIER	AML36
PANELUTSKRIFTSMÅTT	Rectangular - 28.98mm x 19.05mm
FÖRPACKNING	Bulk
DRIFTSTEMPERATUR	-
MONTERINGSTYP	Panel Mount, Snap-In
FUKTKÄNSLIGHETSNIVÅ (MSL)	1 (Unlimited)
MEKANISKT LIV	25,000 Cycles
LEDNINGSFRI STATUS / ROHS-STATUS	Lead free / RoHS Compliant
INGRESS PROTECTION	-
BELYSNINGSSPÄNNING (NOMINELL)	250 VAC
BELYSNINGSTYP, FÄRG	Neon, Red
FUNKTIONER	-
ELEKTRISKT LIV	25,000 Cycles
DETALJERAD BESKRIVNING	Rocker Switch DPST 15A (AC) 125V Panel Mount, Snap-In
NUVARANDE OMDÖME	15A (AC)
FÄRG - AKTUATOR / CAP	-
KRETS	DPST
AKTUATOR TYP	Actuator Arm, Cap Required - Illuminated
AKTUATORMARKERING	Varies by Cap

Relaterade etiketter

Honeywell Sensing and Productivity Solutions AML36FBC4AC01	AML36FBC4AC01-distributör	AML36FBC4AC01-leverantör
AML36FBC4AC01-pris	AML36FBC4AC01-bilder	AML36FBC4AC01-bild
AML36FBC4AC01 PDF-datablad	AML36FBC4AC01 Ladda ner datablad	AML36FBC4AC01-datablad
AML36FBC4AC01 lager	Köp AML36FBC4AC01	Köp Honeywell Sensing and Productivity Solutions AML36FBC4AC01
Honeywell Sensing and Productivity Solutions AML36FBC4AC01	Honeywell Sensing and Productivity Solutions-leverantör	Honeywell Sensing and Productivity Solutions-distributör
Honeywell Sensing and Productivity Solutions AML36FBC4AC01	HONEYWELL AML36FBC4AC01	Honeywell Sensing and Control EMEA AML36FBC4AC01
Honeywell Sensing and Productivity Solutions T&M AML36FBC4AC01		

Relaterade produkter

 <p>AML36FBP7AC01 tillverkare: Honeywell Sensing and Productivity Solutions Beskrivning: SWITCH ROCKER DPST 15A 125V I lager: Out stock RFQ</p>	 <p>AML36FBB4AA01 tillverkare: Honeywell Sensing and Productivity Solutions Beskrivning: SWITCH ROCKER SPST 15A 125V I lager: Out stock RFQ</p>
 <p>AML36FBC7AC01 tillverkare: Honeywell Sensing and Productivity Solutions Beskrivning: SWITCH ROCKER DPST 15A 125V I lager: Out stock RFQ</p>	 <p>AML36FBB4AC01 tillverkare: Honeywell Sensing and Productivity Solutions Beskrivning: SWITCH ROCKER DPST 15A 125V I lager: 5 pcs RFQ</p>
 <p>AML41DBE2 tillverkare: Honeywell Sensing and Productivity Solutions Beskrivning: INCAND DISP IND SQ 2 LAMP I lager: Out stock RFQ</p>	 <p>AML36FBC4AA01 tillverkare: Honeywell Sensing and Productivity Solutions Beskrivning: SWITCH ROCKER SPST 15A 125V I lager: Out stock RFQ</p>
 <p>AML35FBC4AC01 tillverkare: Honeywell Sensing and Productivity Solutions Beskrivning: SWITCH TOGGLE DPST 15A 125V I lager: Out stock RFQ</p>	 <p>AML41CBA2 tillverkare: Honeywell Sensing and Productivity Solutions Beskrivning: SWITCH INDICATOR SQUARE ILLUM I lager: Out stock RFQ</p>
 <p>AML4 tillverkare: Altech Corporation Beskrivning: SWITCH UNITPB 30MM RED NON ILL M I lager: Out stock RFQ</p>	 <p>AML35FBC7AC01 tillverkare: Honeywell Sensing and Productivity Solutions Beskrivning: SWITCH TOGGLE DPST 15A 125V I lager: Out stock RFQ</p>
 <p>AML41DBA2 tillverkare: Honeywell Sensing and Productivity Solutions Beskrivning: SWITCH INDICATOR SQUARE ILLUM I lager: 32 pcs RFQ</p>	 <p>AML36FBB7AC01 tillverkare: Honeywell Sensing and Productivity Solutions Beskrivning: SWITCH ROCKER DPST 15A 125V I lager: 8 pcs RFQ</p>