





Grayhill, Inc.

62S11-H9-060SH

Artikelnummer:	62S11-H9-060SH
Tillverkare / Brand:	Grayhill, Inc.
Produktbeskrivning	ROTARY ENCODER OPTICAL 32PPR
Datablad:	 62S11-H9-060SH.pdf
RoHS status	 Blyfri / Överensstämmer med RoHS
Skicka från	Hong Kong
Leveransväg	DHL/Fedex/TNT/UPS/EMS

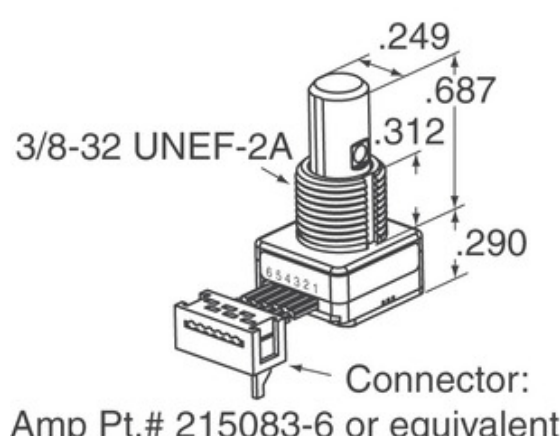
[OFFERTFÖRFRÅGAN](#)

Bilden kan vara representation. Se specifikationer för produktinformation.



Specifikationer för 62S11-H9-060SH

ARTIKELNUMMER	62S11-H9-060SH
TILLVERKARE	Grayhill, Inc.
BESKRIVNING	ROTARY ENCODER OPTICAL 32PPR
LEDNINGSFRI STATUS / ROHS-STATUS	Blyfri / Överensstämmer med RoHS
DATABLAD	 62S11-H9-060SH.pdf
SPÄNNING - TILLFÖRSEL	5V
AVSLUTNINGSSTIL	Cable Leads
SERIER	62S
ROTATIONSLIVSLÄNGD (CYKLAR MIN)	1M
PULSER PER REVOLUTION	32
UTMATNINGSTYP	Quadrature (Incremental)
ANDRA NAMN	62S11H9060SH
ORIENTERING	Vertical
MONTERINGSTYP	Panel Mount
FUKTKÄNSLIGHETSNIVÅ (MSL)	1 (Unlimited)
TILLVERKARENS NORMALA LEDTID	8 Weeks
LEDNINGSFRI STATUS / ROHS-STATUS	Lead free / RoHS Compliant
KODARE TYP	Optical
SPÄRR~~POS=TRUNC	Yes
INBYGGD SWITCH	Yes
AKTUATOR TYP	1/4" Dia Flatted End

Relaterade etiketter

Grayhill, Inc. 62S11-H9-060SH	62S11-H9-060SH-distributör	62S11-H9-060SH-leverantör
62S11-H9-060SH-pris	62S11-H9-060SH-bilder	62S11-H9-060SH-bild
62S11-H9-060SH PDF-datablad	62S11-H9-060SH Ladda ner datablad	62S11-H9-060SH-datablad
62S11-H9-060SH lager	Köp 62S11-H9-060SH	Köp Grayhill, Inc. 62S11-H9-060SH
Grayhill, Inc. 62S11-H9-060SH	Grayhill, Inc.-leverantör	Grayhill, Inc.-distributör
Grayhill, Inc. 62S11-H9-060SH	Grayhill Inc. 62S11-H9-060SH	

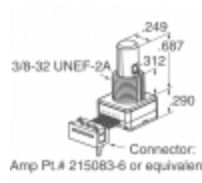
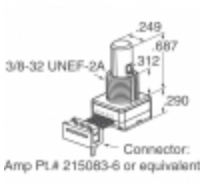
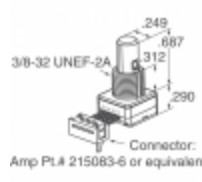
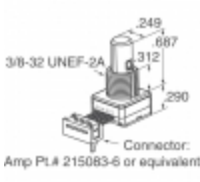
Relaterade produkter

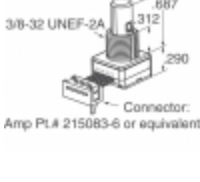
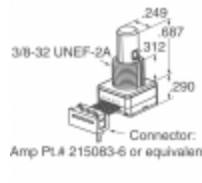
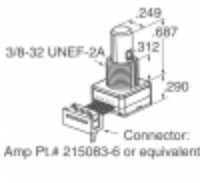
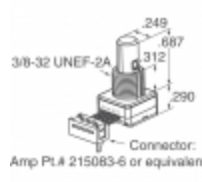
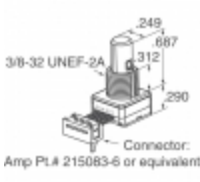
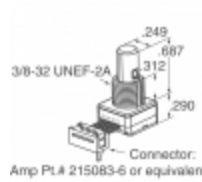
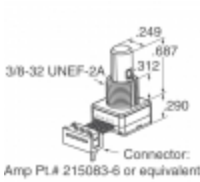
 <p>62S11-L0-040C tillverkare: Grayhill, Inc. Beskrivning: ROTARY ENCODER OPTICAL 32PPR I lager: Out stock</p> <p>RFQ</p>	 <p>62S11-H9-050S tillverkare: Grayhill, Inc. Beskrivning: ROTARY ENCODER OPTICAL 32PPR I lager: Out stock</p> <p>RFQ</p>
 <p>62S11-L0-020C tillverkare: Grayhill, Inc. Beskrivning: ROTARY ENCODER OPTICAL 32PPR I lager: Out stock</p> <p>RFQ</p>	 <p>62S11-L0-020CH tillverkare: Grayhill, Inc. Beskrivning: ROTARY ENCODER OPTICAL 32PPR I lager: Out stock</p> <p>RFQ</p>
 <p>62S11-L0-040S tillverkare: Grayhill, Inc. Beskrivning: ROTARY ENCODER OPT 32PPR 4" CBL I lager: Out stock</p> <p>RFQ</p>	 <p>62S11-H9-040S tillverkare: Grayhill, Inc. Beskrivning: ROTARY ENCODER OPTICAL 32PPR I lager: Out stock</p> <p>RFQ</p>
 <p>62S11-H9-020S tillverkare: Grayhill, Inc. Beskrivning: ROTARY ENCODER OPTICAL 32PPR I lager: Out stock</p> <p>RFQ</p>	 <p>62S11-H9-P tillverkare: Grayhill, Inc. Beskrivning: ROTARY ENCODER OPTICAL 32PPR I lager: Out stock</p> <p>RFQ</p>
 <p>62S11-H9-PH tillverkare: Grayhill, Inc. Beskrivning: ROTARY ENCODER OPTICAL 32PPR I lager: Out stock</p> <p>RFQ</p>	 <p>62S11-H9-025S tillverkare: Grayhill, Inc. Beskrivning: ROTARY ENCODER OPTICAL 32PPR I lager: Out stock</p> <p>RFQ</p>
 <p>62S11-H9-060C tillverkare: Grayhill, Inc. Beskrivning: ROTARY ENCODER OPTICAL 32PPR I lager: Out stock</p> <p>RFQ</p>	 <p>62S11-H9-040C tillverkare: Grayhill, Inc. Beskrivning: ROTARY ENCODER OPTICAL 32PPR I lager: Out stock</p> <p>RFQ</p>