

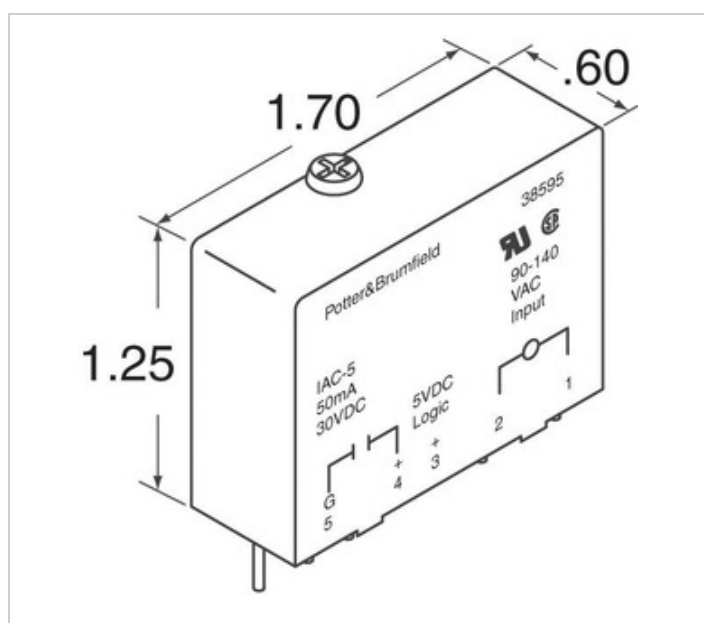

OAC-15

Artikelnummer:	OAC-15
Tillverkare / Brand:	Agastat Relays / TE Connectivity
Produktbeskrivning	AC OUTPUT MODULE 3A
Datablad:	PDF OAC-15.pdf
RoHS status	 Blyfri / Överensstämmer med RoHS
Skicka från	Hong Kong
Leveransväg	DHL/Fedex/TNT/UPS/EMS



Bilden kan vara representation. Se specifikationer för produktinformation.

[OFFERTFÖRFRÅGAN](#)







Specifikationer för OAC-15

ARTIKELNUMMER	OAC-15
TILLVERKARE	Agastat Relays / TE Connectivity
BESKRIVNING	AC OUTPUT MODULE 3A
LEDNINGSFRI STATUS / ROHS-STATUS	Blyfri / Överensstämmer med RoHS
DATABLAD	PDF OAC-15.pdf
SPÄNNING - UTGÅNG	24 ~ 280VAC
SPÄNNING - INGÅNG	15VDC
TYP	AC Output Module
SLÅ PÅ TID	8.33ms
STÅNG AV TIDEN	8.33ms
STIL	Standard
SERIER	OAC
ANDRA NAMN	2-1393028-3 OAC15 PB700
TILLVERKARENS NORMALA LEDTID	15 Weeks
LEDNINGSFRI STATUS / ROHS-STATUS	Lead free / RoHS Compliant
FUNKTIONER	Hold Down Screw
DETALJERAD BESKRIVNING	AC Output Module Output Module 3A 24 ~ 280VAC Output 15VDC Supply
STRÖMUTGÅNG	3A
NUVARANDE - INPUT	16mA
FÄRG	Black

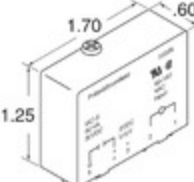
Relaterade etiketter

Agastat Relays / TE Connectivity OAC-15	OAC-15-distributör	OAC-15-leverantör
OAC-15-pris	OAC-15-bilder	OAC-15-bild
OAC-15 PDF-datablad	OAC-15 Ladda ner datablad	OAC-15-datablad
OAC-15 lager	Köp OAC-15	Köp Agastat Relays / TE Connectivity OAC-15
Agastat Relays / TE Connectivity OAC-15	Agastat Relays / TE Connectivity-leverantör	Agastat Relays / TE Connectivity-distributör
Agastat Relays / TE Connectivity OAC-15	Axicom Relays / TE Connectivity OAC-15	Buchanan Terminal Blocks / TE Connectivity OAC-15
CGS Resistors / TE Connectivity OAC-15	CII / TE Connectivity OAC-15	Elcon Connectors / TE Connectivity OAC-15
Holsworthy Resistors / TE Connectivity OAC-15	Kilovac Relays / TE Connectivity OAC-15	Neohm Resistors / TE Connectivity OAC-15
OEG Relays / TE Connectivity OAC-15	Products Unlimited Transformers & Relays / TE Conn OAC-15	Q-Cee's / TE Connectivity OAC-15
Schrack Relays / TE Connectivity OAC-15	Sigma Inductors / TE Connectivity OAC-15	TE Connectivity's Agastat Relays OAC-15
TE Connectivity's Axicom Relays OAC-15	TE Connectivity's Buchanan Terminal Blocks OAC-15	TE Connectivity's CGS Resistors OAC-15
TE Connectivity's CII OAC-15	TE Connectivity's Elcon Connectors OAC-15	TE Connectivity's Holsworthy Resistors OAC-15
TE Connectivity's Neohm Resistors OAC-15	TE Connectivity's OEG Relays OAC-15	TE Connectivity's Q-Cee's OAC-15
TE Connectivity's Schrack Relays OAC-15	TE Connectivity's Sigma Inductors OAC-15	TE Connectivity's Products Unlimited Transformers OAC-15
TE Connectivity's Kilovac Relays OAC-15		

Relaterade produkter

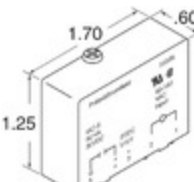
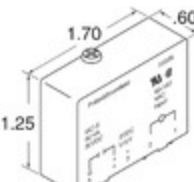
 <p>OAC-15A tillverkare: Agastat Relays / TE Connectivity Beskrivning: AC OUTPUT MODULE 3A I lager: Out stock</p> <p>RFQ</p>	 <p>OAC15 tillverkare: Crydom Beskrivning: AC OUTPUT MODULE 3A I lager: Out stock</p> <p>RFQ</p>
 <p>OAC15A tillverkare: Crydom Beskrivning: AC OUTPUT MODULE 3A I lager: Out stock</p> <p>RFQ</p>	 <p>OAC-24 tillverkare: Agastat Relays / TE Connectivity Beskrivning: AC OUTPUT MODULE 3A I lager: 105 pcs</p> <p>RFQ</p>
 <p>OAC-24A tillverkare: Agastat Relays / TE Connectivity Beskrivning: AC OUTPUT MODULE 3A I lager: Out stock</p> <p>RFQ</p>	 <p>OAC24 tillverkare: Crydom Beskrivning: AC OUTPUT MODULE 3.5A I lager: 6 pcs</p> <p>RFQ</p>
 <p>OAC24A tillverkare: Crydom Beskrivning: AC OUTPUT MODULE 3.5A I lager: Out stock</p> <p>RFQ</p>	 <p>OAC-24H tillverkare: Agastat Relays / TE Connectivity Beskrivning: AC OUTPUT MODULE 5A I lager: Out stock</p> <p>RFQ</p>
 <p>OAC-5H tillverkare: Agastat Relays / TE Connectivity Beskrivning: AC OUTPUT MODULE 5A I lager: 497 pcs</p> <p>RFQ</p>	 <p>OAC24RN tillverkare: Crydom Beskrivning: AC OUTPUT MODULE 3.5A I lager: Out stock</p> <p>RFQ</p>
 <p>OAC-5A tillverkare: Agastat Relays / TE Connectivity Beskrivning: AC OUTPUT MODULE 3A I lager: 289 pcs</p> <p>RFQ</p>	 <p>OAC-5 tillverkare: Agastat Relays / TE Connectivity Beskrivning: AC OUTPUT MODULE 3A I lager: 10 pcs</p> <p>RFQ</p>

