



Omron

B3U-3000PM-B

Artikelnummer:

B3U-3000PM-B

Tillverkare / Brand:

Omron

Produktbeskrivning

SWITCH TACTILE SPST-NO 0.05A 12V

Datablad:

 B3U-3000PM-B.pdf

RoHS status

 Blyfri / Överensstämmer med RoHS

Skicka från

Hong Kong

Leveransväg

DHL/Fedex/TNT/UPS/EMS

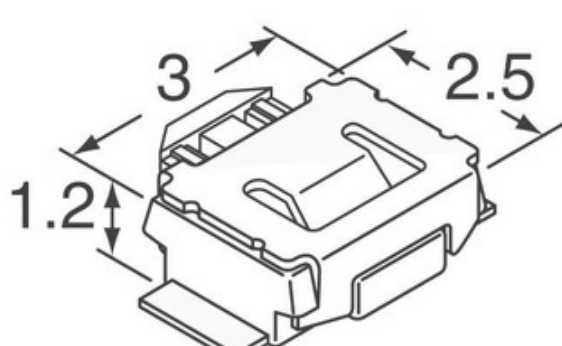

Bilden kan vara representation. Se specifikationer för produktinformation.

[OFFERTFÖRFRÅGAN](#)













Specifikationer för B3U-3000PM-B

ARTIKELNUMMER	B3U-3000PM-B
TILLVERKARE	Omron
BESKRIVNING	SWITCH TACTILE SPST-NO 0.05A 12V
LEDNINGSFRI STATUS / ROHS-STATUS	Blyfri / Överensstämmer med RoHS
DATABLAD	 B3U-3000PM-B.pdf
AVSLUTNINGSSSTIL	SMD (SMT) Tab
BYT RESA	0.20mm
BYT FUNKTION	Off-Mom
SERIER	B3U
FÖRPACKNING	Original-Reel®
ÖVERSIKT	3.00mm x 2.50mm
ANDRA NAMN	Z8276DKR
DRIFTSTEMPERATUR	-25°C ~ 70°C
OPERATIVSTYRKA	162gf
MONTERINGSTYP	Surface Mount, Right Angle
FUKTKÄNSLIGHETSNIVÅ (MSL)	1 (Unlimited)
MEKANISKT LIV	100,000 Cycles
TILLVERKARENS NORMALA LEDTID	13 Weeks
LEDNINGSFRI STATUS / ROHS-STATUS	Lead free / RoHS Compliant
INGRESS PROTECTION	Dust Proof
BELYSNINGSPÄNNING (NOMINELL)	-
BELYSNINGSTYP, FÄRG	-
BELYSNING	Non-Illuminated
FUNKTIONER	-
DETALJERAD BESKRIVNING	Tactile Switch SPST-NO Side Actuated Surface Mount, Right Angle
KONTAKTVÄRDERING @ SPÄNNING	0.05A @ 12VDC
KRETS	SPST-NO
AKTUATOR TYP	Rectangular Button
AKTIVERINGSORIENTERING	Side Actuated
ACTUATOR MATERIAL	-
ACTUATOR LÄNGD, HÖGER VINKEL	-
AKTIVERINGSHÖJD FRÅN PCB, VERTIKAL	-

Relaterade etiketter

Omron B3U-3000PM-B	B3U-3000PM-B-distributör	B3U-3000PM-B-leverantör
B3U-3000PM-B-pris	B3U-3000PM-B-bilder	B3U-3000PM-B-bild
B3U-3000PM-B PDF-datablad	B3U-3000PM-B Ladda ner datablad	B3U-3000PM-B-datablad
B3U-3000PM-B lager	Köp B3U-3000PM-B	Köp Omron B3U-3000PM-B
Omron B3U-3000PM-B	Omron-leverantör	Omron-distributör
Omron B3U-3000PM-B	Omron Electronics Inc-IA Div B3U-3000PM-B	Omron Electronics Inc-EMC Div B3U-3000PM-B
Omron Electronics LLC B3U-3000PM-B		

Relaterade produkter

 <p>B3U-3100PM tillverkare: Omron Beskrivning: SWITCH TACTILE SPST-NO 0.05A 12V I lager: Out stock</p> <p>RFQ</p>	 <p>B3U-1000P-B tillverkare: Omron Beskrivning: SWITCH TACTILE SPST-NO 0.05A 12V I lager: Out stock</p> <p>RFQ</p>
 <p>B3U-3100P-B tillverkare: Omron Beskrivning: SWITCH TACTILE SPST-NO 0.05A 12V I lager: Out stock</p> <p>RFQ</p>	 <p>B3U-3100P tillverkare: Omron Beskrivning: SWITCH TACTILE SPST-NO 0.05A 12V I lager: Out stock</p> <p>RFQ</p>
 <p>B3U-1000P tillverkare: Omron Beskrivning: SWITCH TACTILE SPST-NO 0.05A 12V I lager: Out stock</p> <p>RFQ</p>	 <p>B3U-1100PM tillverkare: Omron Beskrivning: SWITCH TACTILE SPST-NO 0.05A 12V I lager: Out stock</p> <p>RFQ</p>
 <p>B3U-3000PM tillverkare: Omron Beskrivning: SWITCH TACTILE SPST-NO 0.05A 12V I lager: Out stock</p> <p>RFQ</p>	 <p>B3U-3000P-B tillverkare: Omron Beskrivning: SWITCH TACTILE SPST-NO 0.05A 12V I lager: Out stock</p> <p>RFQ</p>
 <p>B3U-1100P-B tillverkare: Omron Beskrivning: SWITCH TACTILE SPST-NO 0.05A 12V I lager: Out stock</p> <p>RFQ</p>	 <p>B3U-1100P tillverkare: Omron Beskrivning: SWITCH TACTILE SPST-NO 0.05A 12V I lager: Out stock</p> <p>RFQ</p>
 <p>B3U-3000P tillverkare: Omron Beskrivning: SWITCH TACTILE SPST-NO 0.05A 12V I lager: Out stock</p> <p>RFQ</p>	 <p>B3U-3100PM-B tillverkare: Omron Beskrivning: SWITCH TACTILE SPST-NO 0.05A 12V I lager: Out stock</p> <p>RFQ</p>

